

SCRimmer II™

with
Multi-Link™

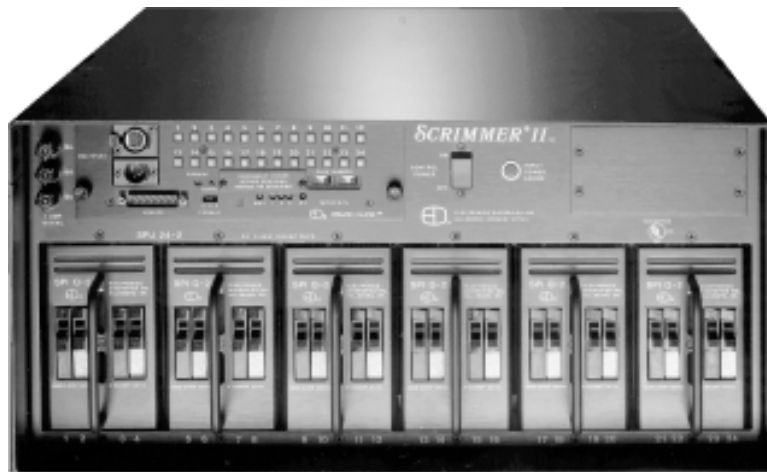

User Manual



Introduction

This User's Manual is supplied with your Scrimmer II. Copies of this manual may be obtained from Electronics Diversified, Inc., for a nominal charge. It is recommended that you copy those portions of this manual applicable to your present use in the installation, maintenance or repair and preserve the original in a safe place.

Copyright 1998, by Electronics diversified, Inc. All rights reserved.

No part of this Manual may be reproduced by any means, graphic, electronic, or mechanical, including photocopying, recording, taping, or information storage and retrieval systems, without the express written permission of Electronics Diversified, Inc., except in connection with installation, repair and maintenance of installed Scrimmer II Power Packs.

Table of Contents

Description	2
Front Panel	2
Rear Panel	4
Input Power Wiring	4
Three-Phase Wiring	4
Single-Phase Wiring	5
Input Control Connections	5
Analog Control	5
Analog Connector	5
Connector Wiring	5
Multiplex Control	6
Multi-Link Connectors	7
USITT DMX-512 Digital	7
USITT AMX-192 Analog Multiplex	7
Fiber-Link Optical Multiplex	7
Multiplex Cables	7
Self Test	7
Dimmer Output Test	7
Lamp Preheat	8
Calibration	8
High End Calibration	8
Low End Calibration	8
Wall Mounting	9
Solid-State Relay Replacement	9
Troubleshooting Guide	10
Maintenance	10
Service	10
Registration	11



WARNING:

Maximum ambient operation and storage environment for this equipment is 104°F (40°C), with 90% humidity, non-condensing. Extreme caution is advised when having liquids, food and cigarettes around any equipment. During severe electrical storms, equipment should be disconnected. Failure to adhere to these requirements may result in malfunction or serious damage.

Description

The SCRimmer II with Multi-Link dimmer pack is a compact lighting control system. A variety of plug-in solid-state dimmer modules with ratings from 1,000 to 12,000 watts are available. With Multi-Link, a variety of control formats are supported.

It is recommended that you read the following instructions before operating your dimmer pack for the first time.

Location: Although very efficient, solid-state dimmers generate heat. Be sure a free flow of air is allowed through the ventilation openings on the front and rear of the cabinet. Locate the dimmer pack close to the power source. Either avoid long power cable runs or increase the input power wire size.

Dimmer Type: This dimmer is designed to properly dim 120VAC incandescent or quartz lamps. Low voltage lamps operated through a standard (non-electronic) transformer with a 120VAC primary may also be operated. Do Not connect any other type of load such as motors or fluorescent lamps to this dimmer.

Power Source: This dimmer is designed to operate on 120 volts, 60Hz, AC power. This dimmer should be connected to a molded-case circuit breaker properly sized for the load.

Supply Cord: The dimmer power cord is not supplied. Refer to the INPUT Power Wiring section for proper wiring.



WARNING:

Do not connect this Dimmer to other than the specified voltage, or to direct current.

Front Panel

- Input Power Error Indicator:**
This indicator will light if there is voltage between the neutral conductor and the dimmer chassis.

IMPORTANT!

If this indicator is on, disconnect power immediately and check for improper input power wiring. Refer to the INPUT POWER WIRING section.

- Phase Change Plug:**
On phase-change models, this plug allows the dimmer pack to be wired for either single-phase or three-phase power.
- Dimmer Module:**
The plug-in dimmer modules contain the power components of each individual dimmer circuit.



Front Panel (cont'd)

4. **Dimmer Circuit Breakers:**
One fully magnetic circuit breaker is supplied for each dimming circuit. Turn off the corresponding breaker when re-lamping or connecting loads.
5. **Control Power Switch:**
Turn on this switch to power the control electronics. When this switch is off, the dimmer will not respond to any external control signals and the dimmer preheat is off.
6. **Power Indicators:**
These green indicators will light when power is applied to the corresponding phases. All three lights should light on three-phase dimmers, and lights 1 and 2 should light on single-phase dimmers.
7. **Control Power Fuses:**
These three fuses protect the Multi-Link control module.
8. **Dimmer Output Test Buttons/Status Indicators:**
Each yellow indicator will light as bright as the output of the individual dimmer. When the button is pressed in, the corresponding dimmer will be forced to full output and the yellow indicator will be at maximum brightness.
9. **Analog Control Input:**
Connect the analog cable from an analog 0- +10V controller here.
10. **Multiplex Signal Format Switch:**
Set this switch to "D" for USITT DMX-512 digital, or "A" for AMX-192 control formats.
11. **Dimmer Pack Number:**
These two thumbwheel switches select the dimmer pack address for multiplexed dimmer formats.
12. **Configure Button:**
This pushbutton is used to enter new multiplex data formats, self-test patterns, or different dimmer pack addresses. Press this pushbutton after any change is made in multiplex data formats, self-test patterns, or dimmer pack addresses.
13. **Multiplex Control Input:**
Connect the multiplex cable from the control console here.
14. **Multiplex Control Output:**
This connector is paralleled to the Multiplex Control Input connector. Use this connector to add additional dimmers.
15. **Multiplex Signal Presence Indicator:**
The yellow indicator lights when a valid multiplex signal is received.
16. **Dimmer Overtemp Indicator:**
This red indicator will light when the dimmer pack is shut down due to an over-temperature condition. The dimmer pack will re-energize when it has cooled down to an acceptable temperature.
17. **Preheat Level:**
This control is used to set the preheat level of the lamps. Turn it clockwise to increase the preheat level.
18. **Calibration Access Plate:**
Removal of this plate allows access to calibration potentiometers and test points. Refer to Calibration section.

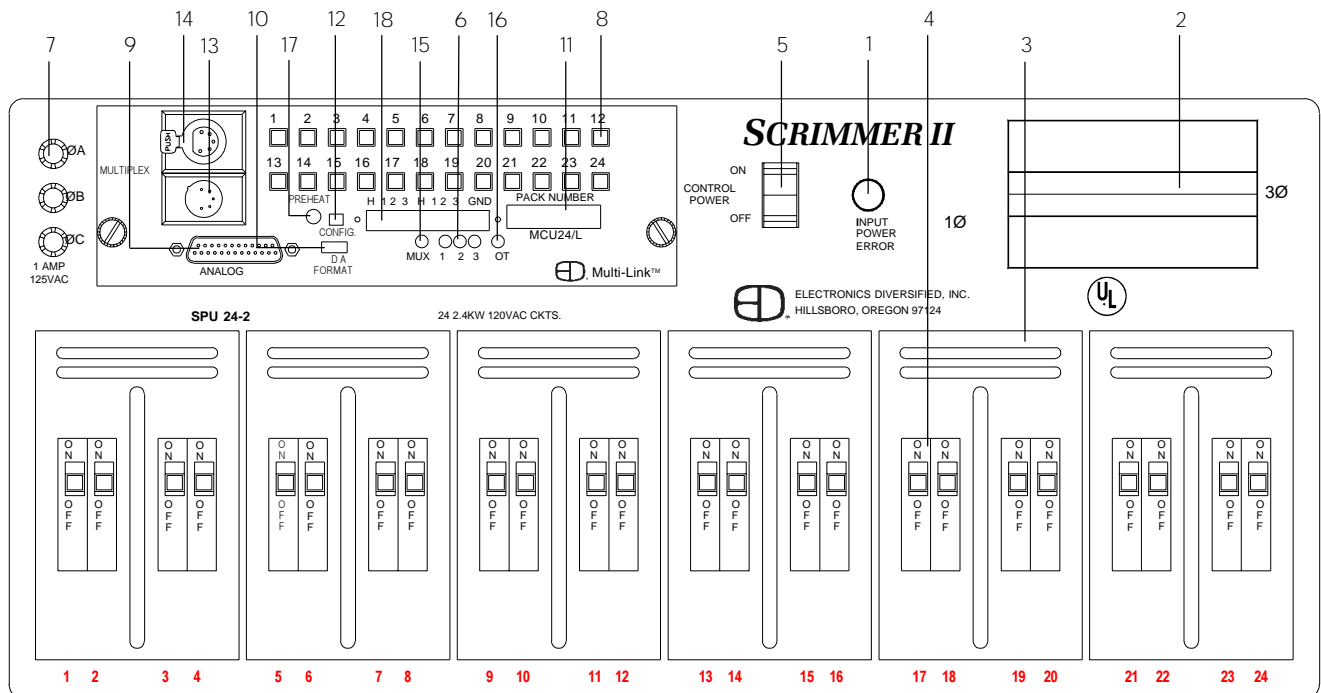

Rear Panel

1. Convenience Outlet:
External devices of up to 20 amps may be connected here.
2. Circuit Breaker:
This circuit breaker provides branch circuit protection for the convenience outlet.
3. Dimmer Outputs:
Loads should be at least 25 watts.

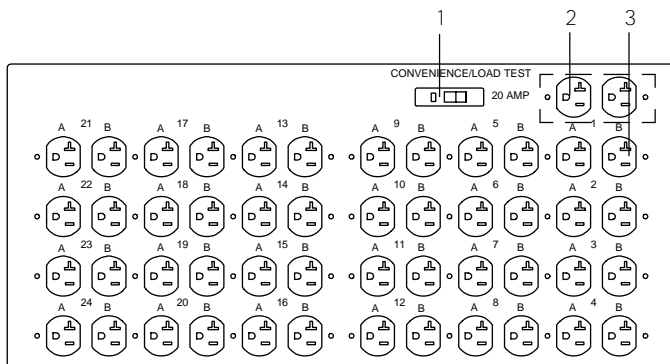

IMPORTANT!
Turn off the corresponding circuit breaker when re-lamping or connecting loads.

Input Power Wiring

It is strongly recommended that the input power wiring be installed by a qualified electrician.

This unit must be connected to a grounded power source! If a grounded power source is not available, contact a qualified electrician.

IMPORTANT!
Before connecting the input power, make sure the power source is *turned off*.
Set all breakers and the control power switch to the *off position*.
Unscrew and remove the dimmer cover. The line input terminal block is located on the right side of the dimmer.

Route the feed cable through the cable clamp and make the required connections to the terminal block and ground lug inside. Snug down all terminal and ground lug screws firmly, watching for stray wire strands which could cause shorts. Replace the cover and tighten the cable clamp.

The SCRimmer II with Multi-Link dimmer can be operated on single- or three-phase power. Each is connected in a different way. Refer to the following instructions for proper connections.

IMPORTANT!
Solid-state dimmers are sensitive to resistance and the resulting voltage drops in the power feed cable. Excessive voltage drops may cause the dimmers to interact and flicker. This is especially true of the neutral conductor. The neutral conductor must be at least the same size as the line conductors. EDI recommends that the size of the neutral conductor be 125% of the line conductors.

Three-Phase Wiring -- 120/208 VAC

Three-phase wiring has three separate hot wires and a neutral.

1. Connect the Ground wire to the lug next to the terminal block. This unit must be grounded.
2. Connect the Neutral wire to the "N" terminal.
3. Connect the Phase A wire to the "Ø A" terminal. Connect the Phase B wire to the "Ø B" terminal. Connect the Phase C wire to the "Ø C" terminal.

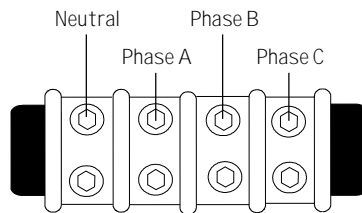

Double-check all connections, and make sure all terminals are tightly secured before replacing cover. Tighten the cable clamp and connect the cable to a suitable power source.

Apply power to the dimmer and check the Input Power Indicator. If it is on, the dimmer is miswired. Turn off power immediately and check the input power wiring.

Turn on the Control Power switch and check the three green power indicators. All three indicators should light.

Connect the loads and turn on all of the circuit breakers.

The dimmer is now ready to use.

IMPORTANT!
Do not connect this dimmer pack to Delta configuration three-phase power sources. The input power requirement for this unit varies with the model. Table 1 gives the input power requirements and suggested wire size for type W wire. For other types of input power wires, consult the National Electric Code.

NOTE: Table 1 is intended for portable installations and shows the minimum acceptable wire sizes for individual type W conductors in free air. If distance from the power source to the dimmer is greater than 50 feet, the wire size will have to be increased. For other types of wires or permanent installations, consult the National Electric Code for proper wire types and sizes.



TABLE 1

Dimmer Model	Line Current	Minimum Wire Size (Type W)
SPP 24-1.2	80 A	No. 6 AWG
SPP 24-1.8	120 A	No. 2 AWG
SPP 24-2	160 A	No. 1 AWG
SPP 12-2	80 A	No. 6 AWG
SPP 12-3	120 A	No. 2 AWG
SPP 6-6	100 A	No. 4 AWG
SPP 6-7	120 A	No. 2 AWG
SPP 6-12	100 A	No. 4 AWG

Single-Phase Wiring -- 120/240 VAC

Single-phase wiring has two separate hot wires and a neutral.

1. Connect the Ground wire to the lug next to the terminal block. *This unit must be grounded.*
2. Connect the Neutral wire to the "N" terminal.
3. Connect the hot wires to the Line 1 and Line 2 terminals.

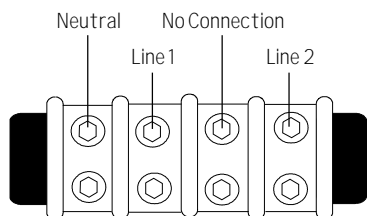

Double check all connections and make sure all terminals are tightly secured before replacing cover. Tighten cable clamp and connect cable to power source.

Apply power to the dimmer and check the Input Power Indicator. If it is on, the dimmer is miswired. Turn off power immediately and check the input power wiring.

Turn on the Control Power switch and check the three green power indicators. Indicators 1 and 3 should light. Indicator 2 should be off. Connect the loads and turn on all of the circuit breakers.

The dimmer is now ready to use.

IMPORTANT!

The dimmer pack is intended to be operated from a 120/240 VAC power source (2 hots and 1 neutral). Do not connect this dimmer to a single 120 volt power source (1 hot and 1 neutral).

The input power requirement for this unit varies with the model. Table 2 gives the input power requirements and suggested wire size for type W wire. For other types of input power wires, consult the National Electric Code.

NOTE: Table 2 is intended for portable installations and shows the minimum acceptable wire sizes for individual type W conductors in free air. If distance from the power source to the dimmer is greater than 50 feet, the wire size will have to be increased. For other types of wires or permanent installations, consult the National Electric Code for proper wire types and sizes.

TABLE 2

Dimmer Model	Line Current	Minimum Wire Size (Type W)
SPP 24-1.2	120 A	No. 2 AWG
SPP 24-1.8	180 A	No. 1/0 AWG
SPP 24-2	240 A	No. 3/0 AWG
SPP 12-2	120 A	No. 2 AWG
SPP 12-3	180 A	No. 1/0 AWG
SPP 6-6	150 A	No. 1 AWG
SPP 6-7	180 A	No. 1/0 AWG

Input Control Connections

This dimmer may be controlled by either an analog output controller 0- +10 volt D.C. or one of three multiplexed output controllers. The following sections describe all control formats.

Analog Control

This dimmer is equipped with a male 25-pin "D" connector for operation from 0 to +10 Volt D.C. analog control voltages.

1. Connect the analog cable to the analog input connector.
2. Set the pack address switches to 00 to disable the self-test and multiplex input features.
3. Press the "Configure" button.

NOTE: If you are using the analog and multiplex controls at the same time, ignore steps 2 and 3.

Analog Connector 25-pin D type

Female mating connector: Cannon #DB-25S

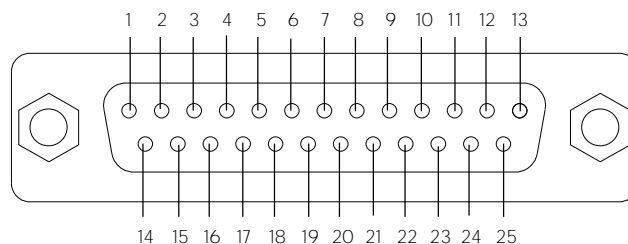

Connector Wiring

The analog control signals are wired to the connector as in Table 3A. If the dimmer you are using is a Model SPP 6-6 (6kw) or SPP 6-7 (7.2kw), use Table 3B, and use Table 3C for SPP 3-12 (12kw) dimmer packs. On all models, control ground is connected to pin 25.

TABLE 3A

Analog Connector Wiring
(12 and 24 dimmer models)

Dimmer Number	Control Pin	Dimmer Number	Control Pin
1	1	13	13
2	2	14	14
3	3	15	15
4	4	16	16
5	5	17	17
6	6	18	18
7	7	19	19
8	8	20	20
9	9	21	21
10	10	22	22
11	11	23	23
12	12	24	24
		Control Ground	25



TABLE 3B
Analog Connector Wiring
(6-dimmer models)

Dimmer Number	Control Pin	Dimmer Number	Control Pin
1	1	1	1
2	3	2	5
3	5	3	9
4	7	Ground	25
5	9		
6	11		
Ground	25		

TABLE 3C
Analog Connector Wiring
(3-dimmer models)

Dimmer Number	Control Pin
1	1
2	3
3	5
Ground	25

Multiplex Control

The Multi-Link controller may be configured for different control formats. When using the multiplex control option, the dimmer "Pack Number" thumbwheels must be set to the proper value.

NOTE: Dimmer pack numbers are in groups of twelve. Pack number 01 is for dimmers 1-12, 02 is for dimmers 13-24, and so on. Table 4A gives the corresponding dimmer numbers for all valid dimmer pack addresses.

TABLE 4A
Dimmer Pack Address Table
(12- and 24-dimmer models)

Pack Address	Dimmer Number	Pack Address	Dimmer Number
00	NONE	22	253-264
01	1-12	23	265-276
02	13-24	24	277-288
03	25-36	25	289-300
04	37-48	26	301-312
05	49-60	27	313-324
06	61-72	28	325-336
07	73-84	29	337-348
08	85-96	30	349-360
09	97-108	31	361-372
10	109-120	32	373-384
11	121-132	33	385-396
12	133-144	34	397-408
13	145-156	35	409-420
14	157-168	36	421-432
15	169-180	37	433-444
16	181-192	38	445-456
17	193-204	39	457-468
18	205-216	40	469-480
19	217-228	41	481-492
20	229-240	42	493-504
21	241-252		

SPP 6-6 and 6-7 dimmer packs using an MCU-6 control module are in groups of six. Use Table 4B for proper addressing.

TABLE 4B
Dimmer Pack Address Table
(6-dimmer models)

Pack Address	Dimmer Number	Pack Address	Dimmer Number
00	NONE	22	127-132
01	1-6	23	133-138
02	7-12	24	139-144
03	13-18	25	145-150
04	19-24	26	151-156
05	25-30	27	157-162
06	31-36	28	163-168
07	37-42	29	169-174
08	43-48	30	175-180
09	49-54	31	181-186
10	55-60	32	187-192
11	61-66	33	193-198
12	67-72	34	199-204
13	73-78	35	205-210
14	79-84	36	211-216
15	85-90	37	217-222
16	91-96	38	223-228
17	197-102	39	229-234
18	103-108	40	235-240
19	109-114	41	241-246
20	115-120	42	247-252
21	121-126		

SPP 3-12 (12kw) dimmer packs using an MCU-3 control module are in groups of three. Use Table 4C for proper addressing.

TABLE 4C
Dimmer Pack Address Table
(3-dimmer models)

Pack Address	Dimmer Number	Pack Address	Dimmer Number
00	NONE	22	64-66
01	1-3	23	67-69
02	4-6	24	70-72
03	7-9	25	73-75
04	10-12	26	76-78
05	13-15	27	79-81
06	16-18	28	82-84
07	19-21	29	85-87
08	22-24	30	88-90
09	25-27	31	91-93
10	28-30	32	94-96
11	31-33	33	97-99
12	34-36	34	100-102
13	37-39	35	103-105
14	40-42	36	106-108
15	43-45	37	109-111
16	46-48	38	112-114
17	49-51	39	115-117
18	52-54	40	118-120
19	55-57	41	121-123
20	58-60	42	124-126
21	61-63		

Usually, the first dimmer pack (dimmers 1-12) is set to **01**, the second dimmer pack (dimmers 13-24) to **02**, and so on. On 24 dimmer models, each dimmer pack uses two numbers, The first pack should be set to **01** (dimmers 1-24), the second pack to **03** (dimmers 25-48), etc. Whenever the dimmer pack number is changed, the **Configure** button must be pressed to enter the change. If a pack is set to **00**, the Multiplex signal is disabled.



Multi-Link Connectors

5-pin XLR type mating connectors:

Female connector
(to next dimmer pack)
Switchcraft No. A5F

Male connector
(from console)
Switchcraft No. A5M



Wiring Connections:
1. Analog Ground
2. Clock/Data -
3. Clock/Data +
4. Analog Multiplex
5. Overtemp

USITT DMX-512 Digital Multiplex

The USITT DMX-512 Digital multiplex format will allow up to 512 dimmers to be controlled from a single cable. In addition to the digital signal, the SCRimmer II with Multi-Link sends an overtemp signal to the control console in the event of an overtemp condition.

1. Set the multiplex signal format switch to **D** (for Digital multiplex).
2. Set the desired pack number (see Multiplex Control section).
3. Press the **Configure** button.
4. Connect a USITT DMX-512 compatible control cable from the control console to the multiplex control input connector.

USITT AMX-192 Analog Multiplex

The Multi-Link AMX-192 analog multiplex format will allow up to 192 dimmers to be controlled from a single cable.

1. Set the multiplex signal format switch to **A** (for Analog multiplex).
2. Set the desired pack number. The AMX-192 standard will only support 192 dimmers. The maximum pack address number that can be used is 16.
3. Press the **Configure** button.
4. Connect an AMX-192 adapter control cable from the control console to the multiplex control input connector.

Fiber-Link Optical Multiplex

The Fiber-Link multiplex format will allow up to 512 dimmers to be controlled from a single fiber-optic cable.

1. Set the desired pack number (see Multiplex Control section).
2. Press the **Configure** button.
3. Connect a Fiber-Link multiplex cable from the control console to the fiber-optic receiver (labeled **IN**).
4. Additional dimmer packs may be daisy-chained by running a Fiber-Link multiplex cable from the fiber-optic transmitter (labeled **OUT**) to the fiber-optic receiver (labeled **IN**) on the next dimmer.

NOTE: If the control power switch is off, or power is disconnected to the dimmer pack, the Fiber-Link signal received at the IN connector, will not be transmitted by the OUT connector. In order to use the Fiber-Link multiplex format, an optional Fiber-Link module must be installed. This module has only fiber-optic connectors, not Multi-Link connectors. Therefore, Multi-Link and Fiber-Link dimmers may not be interchanged unless the control console has dual output.

Multiplex Cables

Standard Multi-Link Cable is used to connect the dimmer pack to USITT DMX-512, or Multi-Link compatible consoles. This cable is also used to interconnect packs for all multiplex formats.

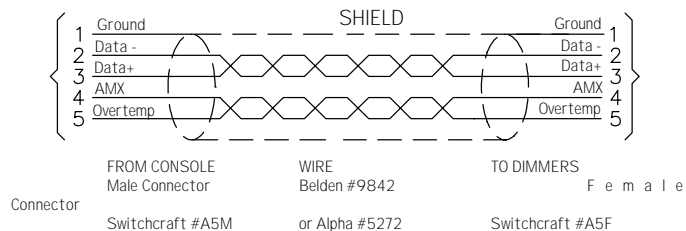

Strand CD80 to Multi-Link Adapter Cable

Strand CD-80 to Multi-Link adapter cable is required for Strand consoles with smaller 4-pin MINI-XLR-type connectors. Use this adapter to connect the first dimmer pack to the console. Additional dimmer packs may be added by using standard Multi-Link cables.

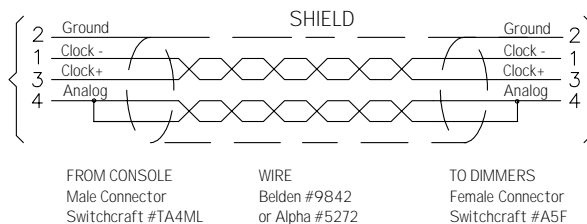

Self Test

The Multi-Link system has three built-in test patterns. The patterns are enabled by selecting dimmer pack numbers of 50, 60, and 70.

To enable a self-test pattern,

1. Select the desired pattern
 - 50 - One dimmer on at a time.
 - 60 - Build (starts with dimmer 1 and adds on additional dimmers).
 - 70 - All dimmers on at once.
2. Press the **Configure** button. The self-test will start immediately. The right hand thumbwheel switch may be changed to vary the speed of the test.
 - 0 is the fastest, 9 is the slowest.

Dimmer Output Test

There is a yellow button on the front panel for each dimmer channel. Pressing it will cause that dimmer to immediately go to full intensity. Pressing the button again will resume normal operation of that channel. The yellow indicator inside each test button shows the same percentage of brightness as the corresponding output.



Lamp Preheat

The lamp preheat adjustment allows a small amount of current flow through the lamp filaments at all times. This preheat (warming current) reduces the shock to the filaments when the lamps are suddenly turned on to full. Increasing the preheat level will significantly increase lamp life, especially in applications where the lamps are rapidly flashed on and off.

Turn the lamp preheat clockwise to increase the lamp preheat and counter-clockwise to reduce it. For optimum preheat adjustment, turn the control all the way clockwise and then slowly turn it counter-clockwise until the lamps stop glowing.

Calibration

This dimmer has been factory calibrated and should never require additional calibration. Before calibration is attempted, make sure that all other equipment has been checked for failure or malfunction, especially the control console.

If the dimmer is ghosting (all lamps glowing), turn the preheat control counter-clockwise.

The SCRimmer II with Multi-Link is designed to be calibrated for a 0- +10 volt analog control signal. If the dimmer is calibrated for other analog control levels, the digital formats (including the test modes) will not work properly.

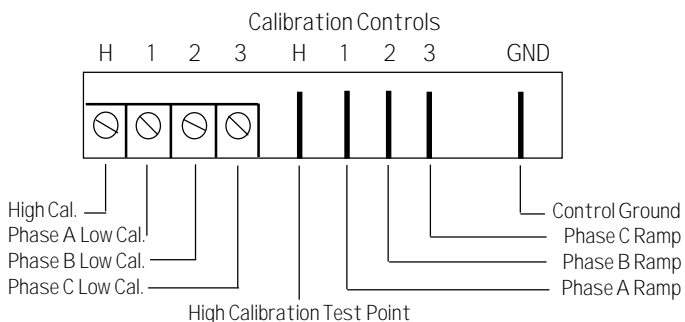

High End Calibration

Remove the calibration access plate. Connect a digital voltmeter between the test point labeled **H** (high cal.) and **GND**. Adjust the **H** calibration potentiometer so meter indicates exactly 9.3 volts.

Low End Calibration

Set the preheat control to ¼ of the way from full counterclockwise. Connect identical 100-500 watt clear lamps to dimmers 1, 5, and 9 (on six-dimmer modules, use 1, 3, 5).

Adjust low cal potentiometer 1 until the lamp connected to dimmer 1 barely glows.

Adjust low cal potentiometer 2 until the lamp connected to dimmer 5 glows at the same intensity as the lamp connected to dimmer 1.

Adjust low cal potentiometer 3 until the lamp connected to dimmer 9 glows at the same intensity as the lamps connectd to dimmers 1 and 5. Reset the preheat control for the desired preheat level.

The dimmer is now properly calibrated.

Wall Mounting

Mount the dimmer to the wall with the front panel facing either right or left as shown.

Allow 12" clearance on all sides, and 18" in front (circuit breaker) side to allow the plug-in dimmers and dimmer control module to be removed. Do not block any of the ventilation openings.

Do not use aluminum wire.

Do not run the control wiring and the line (or load) wiring together or in the same conduits.

Avoid running common neutrals to the load wiring.

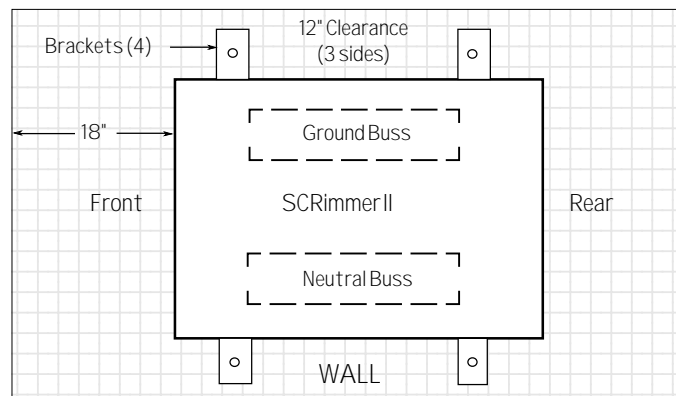

If common load neutrals absolutely must be run (retrofit situations), do not connect circuits of the same phase to the same common neutral wire. Do not run more than three dimmers (three-phase) or two dimmers (single-phase) on a common neutral wire. Choose the size of the neutral wire to handle 120% of the rated dimmer load.

Refer to Table 5A for normal dimmer phasing. For SPP 6-6 and 6-7, use Table 5B.

SPP 3-12 dimmers are each on a different phase.

TABLE 5A
Dimmer Phasing
(12- and 24-dimmer models)

Dimmer Number	Three-Phase	Single Phase	Dimmer Number	Three-Phase	Single Phase
1	Phase A	Line 1	13	Phase A	Line 1
2	Phase A	Line 1	14	Phase A	Line 1
3	Phase A	Line 1	15	Phase A	Line 1
4	Phase A	Line 1	16	Phase A	Line 1
5	Phase B	Line 1	17	Phase B	Line 1
6	Phase B	Line 1	18	Phase B	Line 1
7	Phase B	Line 2	19	Phase B	Line 2
8	Phase B	Line 2	20	Phase B	Line 2
9	Phase C	Line 2	21	Phase C	Line 2
10	Phase C	Line 2	22	Phase C	Line 2
11	Phase C	Line 2	23	Phase C	Line 2
12	Phase C	Line 2	24	Phase C	Line 2

TABLE 5B
Dimmer Phasing
(6-dimmer models)

Dimmer Number	Three Phase	Single Phase
1	Phase A	Line 1
2	Phase A	Line 1
3	Phase B	Line 1
4	Phase B	Line 2
5	Phase C	Line 2
6	Phase C	Line 2



Solid-State Relay Replacement

Determine which plug-in dimmer needs repairing and remove it from the dimmer pack. The solid-state relays are mounted on the heatsink. Quad dimmer modules have two solid state relays. Dimmers 1 and 2 are controlled by the relay with the white-with-brown stripe wire connected to it. Dimmers 3 and 4 are controlled by the relay with the white-with-orange stripe wire connected to it.

Do not install a plug-in dimmer module with the cover removed.

1. Note the arrangement of the power connections (large wires) on the defective solid-state relay, then unplug the connections.

2. Note the orientation of the control connector, then unplug the connector.
3. Remove the relay by removing the two screws which secure it to the heatsink.
4. Apply a thin coating of heatsink compound to the bottom of the new solid-state relay and replace by following steps 1 - 3 in reverse order.
5. Replace the cover before reinstalling the dimmer module into the dimmer pack.

Troubleshooting Guide

Symptom	Possible Cause	Remedy
Nothing works, green indicators 1, 2, and 3 are dark.	Control power switch is off. Input power source is off.	Turn on control power switch. Check input power source.
Nothing works, green indicator 1 is dark, 2 and 3 are on.	Phase A (Line 1) fuse blown. Phase A (Line 1) power source off.	Replace fuse. Check input power source.
Dimmers 5, 6, 7 & 8 don't dim correctly, or snap on instead of dimming.	Phase B fuse blown. Phase B power source off. Single-phase dimmer pack wired to three-phase power.	Replace fuse. Check input power source. Connect dimmer to single-phase power source.
Green indicator 2 is off.	Three-phase dimmer pack wired to single-phase power.	Connect dimmer to three-phase power source.
Dimmers 9, 10, 11 or 12 don't dim correctly, or snap on instead of dimming.	Phase C (Line 2) fuse blown.	Replace fuse.
Green indicator 3 is off.	Phase C (Line 2) power source off.	Check input power source.
A dimmer channel is always on and the corresponding output status indicator is on .	Dimmer channel in test mode. Defective solid-state relay.	Depress the corresponding button to clear the test. Replace the solid-state relay.
A dimmer channel is always on and the corresponding output status indicator is off .	Defective solid-state relay.	Replace the solid-state relay.
A dimmer channel is always off and the corresponding output status indicator is off .	The dimmer module is not plugged in all the way. The solid-state relay control connector is loose, unplugged, or plugged in backwards. Defective solid-state relay.	Make sure dimmer is firmly plugged in. Check control wiring connector to solid state relays. Replace the solid-state relay.
A dimmer channel is always off , but the corresponding output status indicator operates properly.	Defective lamp fixture plugged into dimmer. Dimmer circuit breaker is off. Dimmer circuit breaker is tripped. Defective solid-state relay.	Check the load with a known good fixture. Turn on the circuit breaker. Reset the circuit breaker by turning off and then on. Replace the solid-state relay.
All of the lamps "ghost" (glow).	Lamp preheat set too high. Dimmer out of calibration.	Rotate the preheat control counter-clockwise. Re-calibrate the dimmer.

(cont'd)



Troubleshooting Guide (cont'd)

Symptom	Possible Cause	Remedy
Lamps plugged into dimmers 1 - 4, or 5 - 8, or 9 - 12 ghost.	The corresponding phase low end calibration is out of adjustment.	Re-calibrate the dimmer.
The multiplex signal indicator flashes, lamps flicker, or dimmers refuse to respond to multiplex signal.	Dimmer address set to 00.	Set the dimmer pack address to a valid number.
	Bad multiplex cable. Multiplex format set to wrong setting.	Check the dimmer pack with a known good cable. Set the format switch to the proper format.
Lamps flash, flicker, or sequence.	Dimmer address set to test modes (50-70).	Set the dimmer pack address to a valid number.
	Bad multiplex cable. Multiplex format set to wrong format.	Check the dimmer pack with a known good cable. Set the format switch to the proper setting.
The overtemp lamp is always on or comes on when a dimmer channel is brought up.	The dimmer module is not plugged in all the way.	Make sure dimmer is firmly plugged in.
The dimmer pack overheats.	The cooling vents are blocked. The dimmer pack is full of dust.	Clear any obstructions to the cooling vents. Carefully remove dust and dirt with compressed air or a vacuum cleaner.
	The dimmer is in a very warm location.	Relocate the dimmer to a cooler location.
Lamps go out before the console sliders reach zero.	The analog control console is not set for 0 - +10V output.	Check the output from the console.
	The low-end calibration is out of adjustment.	Re-calibrate the dimmer.
Lamps are on full before console sliders reach full.	The analog control console is not set for 0 - +10V output.	Check the output from the console.
	The high-end calibration is out of adjustment.	Re-calibrate the dimmer.
Input power error light on.	Faulty or incorrect input power wiring.	Do not touch the dimmer pack or anything connected to it. Check for voltage between the ground and neutral conductor. Disconnect the power source and check all input power wiring.

Maintenance

Disconnect Power First!

About once a year (or more frequently, if the Power Pack is used often), remove the modules and inspect the connector pins. Clean them with No. 400 or finer sandpaper and carefully spread the pins SLIGHTLY with a screwdriver.

Disconnect power from the rack before cleaning pins in the housing. If the modules become clogged with air-born dirt, they should be vacuumed. This will increase cooling efficiency and prolong component life.

Service

EDI offers a 24 hour Service / Support Network.

For technical questions about this product or operational assistance, ask for Customer Service at: 1-800-547-2690

You may communicate by FAX: 1-503-629-9877

After Hours Emergency contact: 1-503-645-5533
Ask for Emergency Assistance.

Internet: www.edionline.com

Internet E-Mail: service@edionline.com

If your SCRimmer Power Pack needs repair, call 503-645-5533 for a Return Materials Authorization number, and a **shipping address** will be furnished



Attention SCRimmer II owners!

Please return this registration card immediately.

Your prompt attention to this matter will ensure your receiving updated technical information for this product as it becomes available. Please complete all information. Look for acknowledgment of your registration within 6-8 weeks.

Name: _____

Title: _____

Facility and/or Company: _____

Street Address: _____

City: _____ State: _____ Zip: _____

Phone: _____

Fax: _____

E-mail: _____

Web site: _____

CUT ALONG DOTTED LINE



Mail to:
EDI User Manual Registration
1675 NW Cornelius Pass Road
Hillsboro, Oregon 97124

or FAX to: (503) 629-9877

Revision 2, May 1998

