



LP612 and LP624 User's Manual

Rev. 1.2

LP612 Software Version 1.1

LP624 Software Version 1.0

Leprecon/CAE, Inc

P.O. Box 430, 10087 Industrial Drive, Hamburg, MI 48139-0430 810-231-9373, FAX 810-231-1631
Copyright CAE, Inc. January 1997, Publication # 21-2125C

EZ PROGRAMMING THE LP-600 SERIES

Programming Preset Memories.....

1. Press the "Preset" menu to light the "Page" LED
2. Select desired page (1-4) using display "Up" or "Down" arrows
3. Press "Record" button
4. Set desired look by arranging X scene channel faders
5. Store by pressing bump button beneath desired preset fader on Y scene, continue setting and recording
6. Press "Run" to play scenes back

Programming a Chase.....

1. Press "Chase" button to light "Pattern" LED
2. Select desired pattern (5-11) on display using "Up" arrow
3. Press "Chase" menu button again to light "Step" LED
4. Press "Record" button
5. Set desired look on X scene faders
6. Press the display "Up" key to record & advance to next step, continue to set and record chases
7. Press "Run" key to end programming

To Record Stack Presets.....

1. Press the "Stack" menu button to display 'now' scene.
Use the "Down" key to set now to '—'(CL may momentarily appear).
2. Press the "Stack" menu key again to light the "next" Led.
3. Use the display up and down keys to select a cue number of 1 through 50.
4. Set levels on stage using manual channels or Presets.
5. Press the "Record" key once. The "Record" Led will begin to blink.
6. Press "Record" again to memorize the cue. The next cue number will advance.
7. In record mode, continue setting desired levels on stage and recording cues (stacking).
8. Press "Run" to end recording and activate "Cue Stack".
9. While in "next" mode use display Up and Down keys to call up first cue for playback.
10. Use "Stack" fader to manually crossfade between cues or use GO button to time fade to next cue.

SETUP	4
POWER REQUIREMENTS	4
MICROPLEX OUTPUT	4
DMX OUTPUT.....	4
ANALOG OUTPUT	5
<u>CONNECTOR PIN ASSIGNMENTS : LP612 ONLY</u>	5
<u>CONNECTOR PIN ASSIGNMENTS : LP624 ONLY</u>	6
CONTROL LAYOUT.....	7
STARTUP.....	8
MANUAL MODE.....	9
X AND Y PRESET SCENES.....	9
CROSSFADER	9
MASTER	10
BUMP BUTTONS	10
RUNNING IN MANUAL MODE	12
<u>PATCHING DIMMERS:</u>	13
USING MEMORY PRESETS.....	14
CLEARING MEMORY	14
<u>PRESET MENU: LP612 ONLY</u>	16
<u>PRESET MENU: LP624 ONLY</u>	17
PAGE FREEZE	18
RECORDING PRESETS INTO MEMORY	18
PRESET PLAYBACK.....	20
PREVIEWING PRESETS	20
EDITING PRESETS	21
CUE STACK.....	21
RECORDING STACK SCENES	23
ASSIGNING FADE TIMES	24
DEFAULT FADE TIME.....	25
STACK PLAYBACK.....	25
EDITING CUES	26
CHASE	27
PATTERN	27
STEP	27
RATE	27
PRE-PROGRAMMED CHASES	28
RECORDING NEW CHASES	28
<u>LEVEL CHASES: LP624 ONLY</u>	29
PATTERN EDIT.....	29
STEP EDIT	29
REPAIR AND WARRANTY INFORMATION.....	30

Overview

The LP612 and LP624 were designed with the goal of creating low-cost, high quality control consoles. The LP600 series boards share many features with the larger Leprecon LP1500 consoles, but brings these features within reach of users with a smaller budget. Some of these features are:

Manual scenes

Two scene manual presets. Switchable Add or Solo momentary buttons for each channel. Dipless crossfade between manual scenes. Each channel has a large, easily visible Led indicator.

Preset Memories

Real-time preset faders with switchable Add or Solo bumps. Presets may be "piled on" in any combination. Presets are assigned to one of four memory pages. Preview mode allows cues to be checked without bringing up the scene on stage. An existing cue may easily be edited using the manual scene faders without re-recording the entire cue.

Cue Stack

50 programmable cues with crossfader and go button control. Fade times can be assigned to each scene. A two character display is used to indicate current and next cues, and programmed fade time.

Chaser

Four fixed and seven programmable patterns of up to twenty-four steps each are provided. Programmable patterns are recorded, previewed and edited as easily as the preset cues. The rate of each pattern may be saved with the Chase, eliminating the need to adjust the rate pot when the Chase is recalled. The Chase may be advanced a step at a time manually, or halted momentarily.

Output

Standard output is industry standard Microplex using a three pin XLR connector. The optional DMX 512 output uses the standard 5 pin XLR as specified by USITT, and the analog option uses Cinch-Jones connectors common on other Leprecon equipment.

All output protocols can be used simultaneously.

Model Designations

The LP600 series consists of two consoles; the LP612 and the LP624. As the controls of both consoles are very similar, the designation LP600 is used to describe common features. The sections of this manual specific to either board are marked as "LP612 Only" or "LP624 Only".

Setup

The LP600 connects easily to most types of dimming systems. Microplex, as well as the optional analog and DMX 512 outputs are provided for dimmer control. The flexibility to interface to various systems makes the LP600 a natural choice for building a new system, or upgrading an existing system.

Power requirements

The LP600 console can be powered in two ways.

- a) With Microplex dimmers, the microphone cable between the dimmer and controller supplies board power. No external supply connection is required.
- b) With DMX and analog options, an external supply must be used to power the board. This transformer is supplied as part of the option package. This transformer is rated for 12VAC at 800 milliamps.

If the board is to be used with European power systems, or other 230 volt applications, contact your Leprecon dealer for the correct 230 volt power supply.

Microplex Output

The three pin XLR connectors at the back of the LP600 are used to connect the board to standard Microplex dimmers. This connection will work with Leprecon 360 Microplex dimmers, and has been tested with other products for compatibility.

Microplex is suitable for use in smaller systems, up to 64 channels. Ordinary microphone cable may be used to connect the LP600 to Microplex dimmers.

DMX Output

The DMX 512 digital output on the rear panel offers a fast and reliable way of sending control information to the stage. Simply connect a 5-wire DMX control cable from the console output to the DMX input on the dimmer. As the standard mandates, the LP600 has a 5 pin XLR female connector. Additional dimmers can be "daisy-chained" from the first dimmer, by running additional cables between the dimmers.

DMX512 uses a high speed digital signal, and the correct cable type is essential for reliable operation. Microphone cable is not DMX cable. Use of microphone cable for DMX 512 is not recommended.

The LP600 has been tested and complies fully with the USITT DMX 512/1990 standard, and should pose no compatibility problems with any DMX 512 dimmers from Leprecon or from other manufacturers. Should any suspected incompatibilities be encountered, please contact your Leprecon dealer with the specific dimmer model and manufacturer.

Analog Output

Even with the advent of digital control standards, many portable lighting systems use analog control lines between the console and the dimmer racks. The LP600 provides 0-10 volt analog outputs, using Cinch-Jones connectors. The pin connection of these connectors is identical to that used on many other Leprecon products.

Connector Pin Assignments : LP612 ONLY

The analog version of the LP612 uses two panel mount male Cinch-Jones 8 pin connectors for control output. The pin connections are as follows:

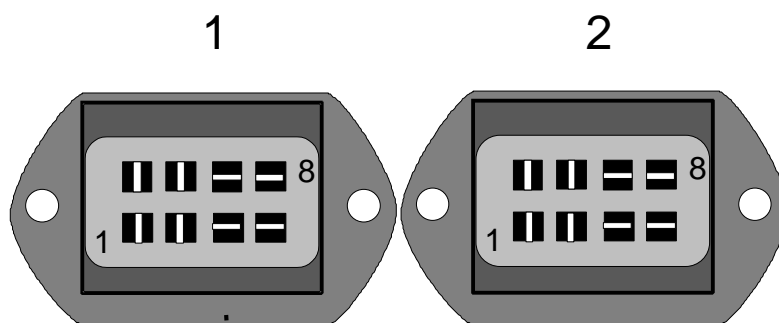

Connector 1

<u>Pin</u>	<u>Function</u>
1	Channel 1
2	Channel 2
3	Channel 3
4	Channel 4
5	Channel 5
6	Channel 6
7	No connect
8	Common

Connector 2

<u>Pin</u>	<u>Function</u>
1	Channel 7
2	Channel 8
3	Channel 9
4	Channel 10
5	Channel 11
6	Channel 12
7	No connect
8	Common

Connector Pin Assignments : LP624 ONLY

The analog version of the LP624 uses one panel mount male Cinch-Jones 27 pin connector for control output. The pin connections are as follows:

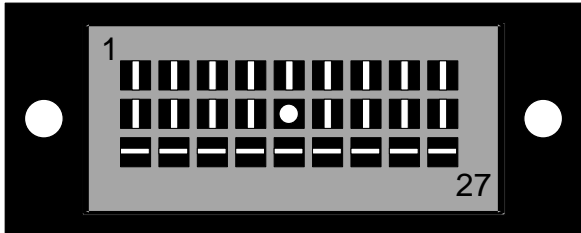

<u>Pin</u>	<u>Function</u>
1-24	Channel 1-24
25	No connection
26,27	Common

Control Layout

The diagram below illustrates some of the controls that will be referenced in this manual. Although the LP612 is shown, the controls of the LP624 are similar.

LP-612 Memory Console Controls

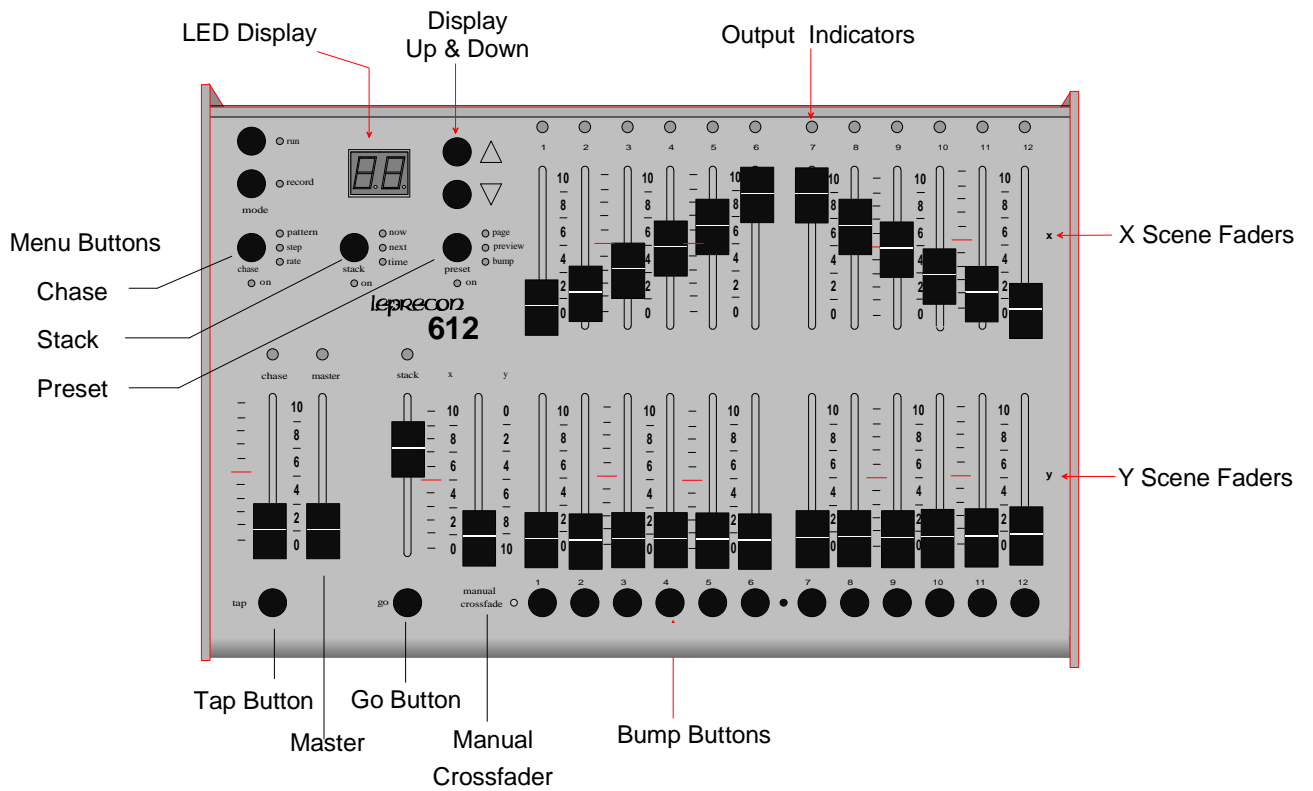

Startup

The console will perform a brief test when power is applied. If the board fails power-on testing, the display will show:



Any error message indicates problems that must be repaired. Some errors may leave the LP600 functional in manual mode only.

Manual Mode

The LP600, in addition to being a powerful memory console, can also be used as a simple two-scene preset board. This allows an untrained operator to immediately start using the board, and learn it's more advanced features as time permits.

To set the LP600 to manual mode, press the 'preset' menu button. The 'page' Led will light. Press the 'down' arrow until the display shows:

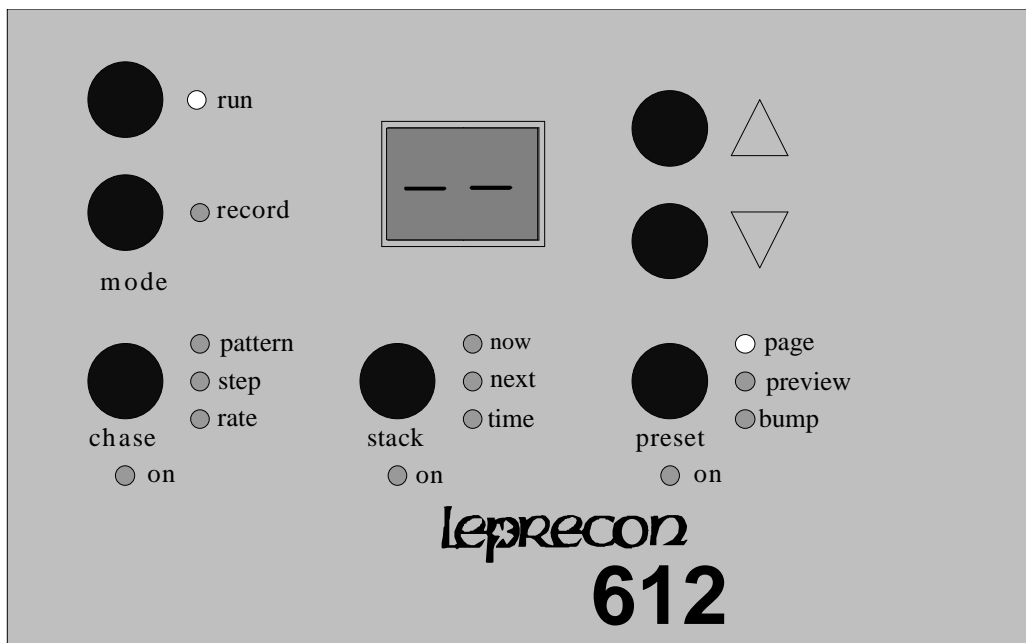

This indicates that the preset memories are off. The 'preset on' Led will be turned off.

X and Y Preset Scenes

The most basic control of the LP600 console is provided by the rows of faders for the two manual scenes, labeled "X" and "Y." Each X and Y pair of faders controls a single console channel, which may be connected to one or more dimmer channels. The green output Led above each channel indicates the channel's relative intensity.

Crossfader

The Manual Crossfader, just to the left of the Y scene faders, is used to fade from the top manual (X) scene to the lower(Y) manual scene. With the fader at the top position, the board output will be set by the levels on the X scene faders. If the crossfader is moved to the bottom position, the levels on stage will be set by the position of the Y scene faders.

Typically, a scene might be set up with the X channel faders in advance, and when that cue is called, the manual crossfader is moved upward together to the X position. This leaves the Y scene available to be set up for the next cue. At the appropriate time, the Crossfader is pulled down to the Y position, and the now inactive X scene available to be set for the next cue.

Master

The Master fader is used to set an overall output level for most board controls. The Master can be used to fade out all scenes of the console for a blackout. The only controls that operate with the Master down are the bump buttons and Chaser. No output from the Cue Stack, Preset scenes or Manual scenes are possible with the master level down.

Bump Buttons

The momentary switches located below the lower scene faders can have different functions depending on the current mode of operation.

The normal RUN mode function of these switches is to momentarily flash a channel or scene on stage without using the fader. The channel or scene drops back out when the button is released.

When cues are being programmed and edited, these buttons are used to select memories for modification. Therefore, when the Record or Edit modes are active, the momentaries DO NOT act as bump buttons.

To display and change the bump button modes, press the 'preset' menu key until the 'bump' Led is lighted. The display will show one of 5 possible modes:

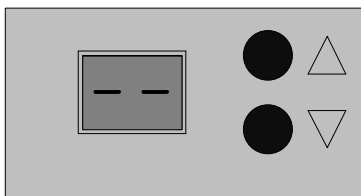

1) Bumps Off

This display indicates the bumps are disabled. No possibility exists of flashing a channel or scene by accidentally pressing a button while running a show.

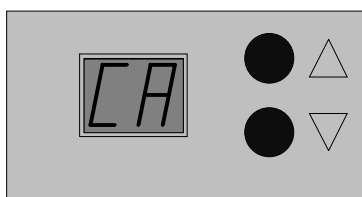

2) Channel Add

Channel Add is the simplest mode of bump operation; pressing a bump button will bring the channel up on stage for as long as the button is pressed without affecting any other channels.

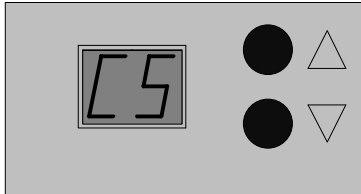

3) Channel Solo

When Solo mode is selected, pressing a bump button will black out any other channels that are up, and bring the selected channel to 100% output. As with bringing down the Grand Master manually, any output from the Chaser will be unaffected by a Solo button being pressed.

The last two bump modes are available only when preset memories are active.

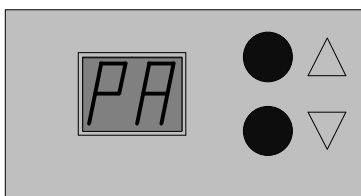

4) Preset Add

When preset memories are active, the lower scene faders are being used as Preset Masters. In this case, the Y scene faders no longer control single channels, but entire memory scenes. The bump buttons can be used to flash the memorized scene. The Channel Add and Channel Solo settings can still be used to bring up a single channel, even though the fader controls an entire scene.

For more information, see "Using Memory Presets".

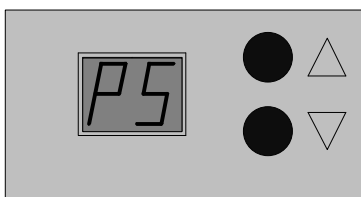

5) Preset Solo

The Preset Solo mode flashes a memorized preset scene on stage, while blacking out any other channels or scenes. The effect is the same as bringing down the master fader momentarily while pressing a bump button. The Chase and any other bumps are the only area of the board not affected by a Solo bump.

Running in Manual Mode

1. Set all X and Y channel faders, and the PRESET master fader to zero.
2. Set the manual crossfader fully downward, to the Y scene position.
3. Bring the MASTER fader up to full. No stage lights will be on.
4. Set up the first scene on the X channel faders.
5. Push the manual crossfader up to the X position, and the X scene will light the stage.
6. Set up the next scene on the inactive Y channel faders.
7. Crossfade to the Y scene by moving the manual crossfader to the Y position.
7. Continue to set up subsequent scenes in this manner; alternating between the X and the Y groups.

Patching Dimmers:

The LP600 series allows for a default 1:1 patch to be used, or a custom dimmer patch can be built.

The custom patch allows the assignment of any dimmer circuit to a specific board channel. Up to 96 DMX dimmer channels, 48 Microplex and 24 analog channels can be patched. More than one dimmer circuit may be assigned to a single board channel; in other words, the channel 8 fader on the console might bring up dimmer circuits 8, 16, and 32. However, a single dimmer circuit can be patched to only one board channel.

To set the patch, press the button labeled "preset" below the numeric display until the yellow Led labeled 'patch' is lighted:

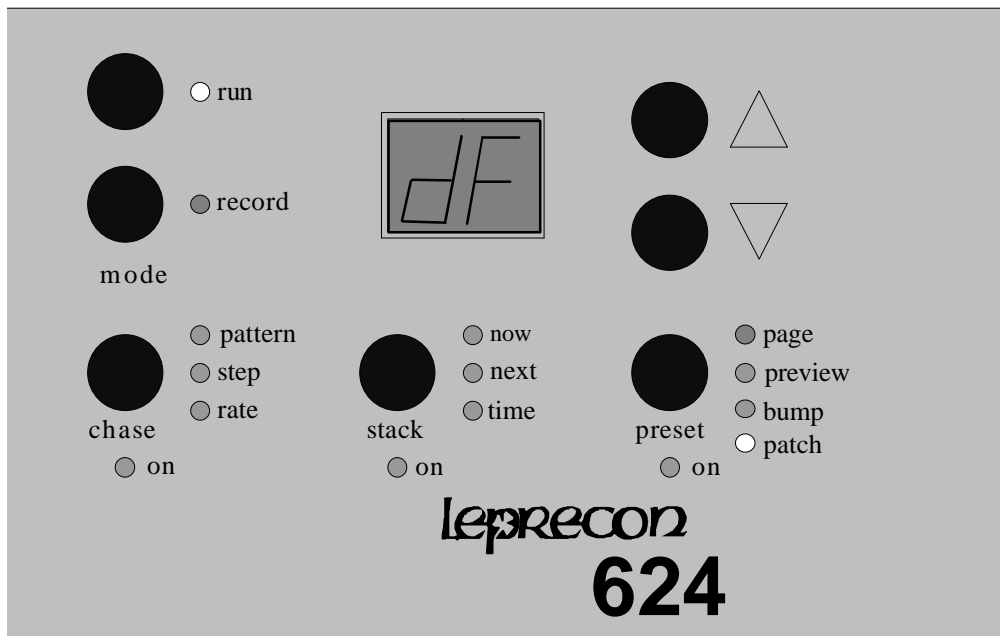

The 'dF' display indicates the default, or straight 1:1 patch is in effect. To switch the board to the custom patch, press the UP arrow next to the display.

The 2 digit display now shows the active dimmer number. The active dimmer can be changed with the UP and DN arrows.

The channel assigned to the active dimmer channel is indicated by the output Led indicator located above each board channel. To assign the active dimmer channel to another board channel, press the bump button of the new channel. The Led for the previously assigned board channel will go out, and the Led for the new board channel will be lighted.

To clear a dimmer assignment, press the bump button of the lighted channel. The bump button will toggle the channel to an 'off' state.

To erase the Custom Patch:

- 1) Press the Preset menu button in the upper left corner of the board. Repeat key press until the "patch" Led is lighted.
- 2) Press the "down" arrow until the label "CL", indicating CLear, appears on the display. The red record Led will begin to blink.
- 3) While the Led is blinking, press the "record" key.
- 4) While the display is blinking, press 'record' again to clear all presets.
- 5) The board will verify the operation by displaying "dE" (default Erase) for a few seconds. The custom patch will now be initialized to a 1:1 patch for 24 dimmers.

Using Memory Presets

The LP600 is much more than a two scene preset board. The lower scene of faders can be converted to individual memory preset masters. This is indicated by the 'preset on' Led being lighted. These presets operate in a "pile-on" mode, allowing more than one preset to be up at any one time.

Clearing Memory

Preset scenes, Stack cues, and Chases recorded into the LP600 are stored in non-volatile memory. This memory system uses no battery, eliminating the need for checking and replacing backup batteries.

When starting to program a new show, it is easier to start with an empty board. The Erase function in the LP600 can be used to delete all scenes, cues, and Chases, leaving the scenes empty and ready to program.

To erase Preset scenes in the LP600:

- 1) Press the Preset menu button in the upper left corner of the board. Repeat key press until the "page" Led is lighted.
- 2) Press the "down" arrow until the label "CL", indicating CLear, appears on the display. The red record Led will begin to blink.
- 3) While the Led is blinking, press the "record" key.
- 4) While the display is blinking, press 'record' again to clear all presets.
- 5) The LP600 will verify the operation by displaying "PE" (Preset Erase) for a few seconds.

To erase Stack Cues in the LP600:

- 1) Press the "stack" menu button in the upper left corner of the board. Repeat key press until the "now" Led is lighted.
- 2) Press the "down" arrow until the label "CL", indicating CLear, appears on the display. The red record Led will begin to blink.
- 3) While the Led is blinking, press the "record" key.
- 4) While the display is blinking, press 'record' again to clear all presets.
- 5) The LP600 will verify the operation by displaying "SE" (Stack Erase) for a few seconds.

To erase Chases in the LP600:

- 1) Press the "Chase" menu button in the upper left corner of the board. Repeat key press until the "pattern" Led is lighted.
- 2) Press the "down" arrow until the label "CL", indicating CLear, appears on the display. The red record Led will begin to blink.
- 3) While the Led is blinking, press the "record" key.
- 4) While the display is blinking, press 'record' again to clear all presets.
- 5) The LP600 will verify the operation by displaying "CE" (Chase Erase) for a few seconds.

Preset Menu: LP612 ONLY

The Preset functions are controlled by pressing the 'preset' menu key on the front panel. When in the Preset mode, this button switches between three items:

page	Page Number
preview	Preview and Edit
bump	Bump Button control

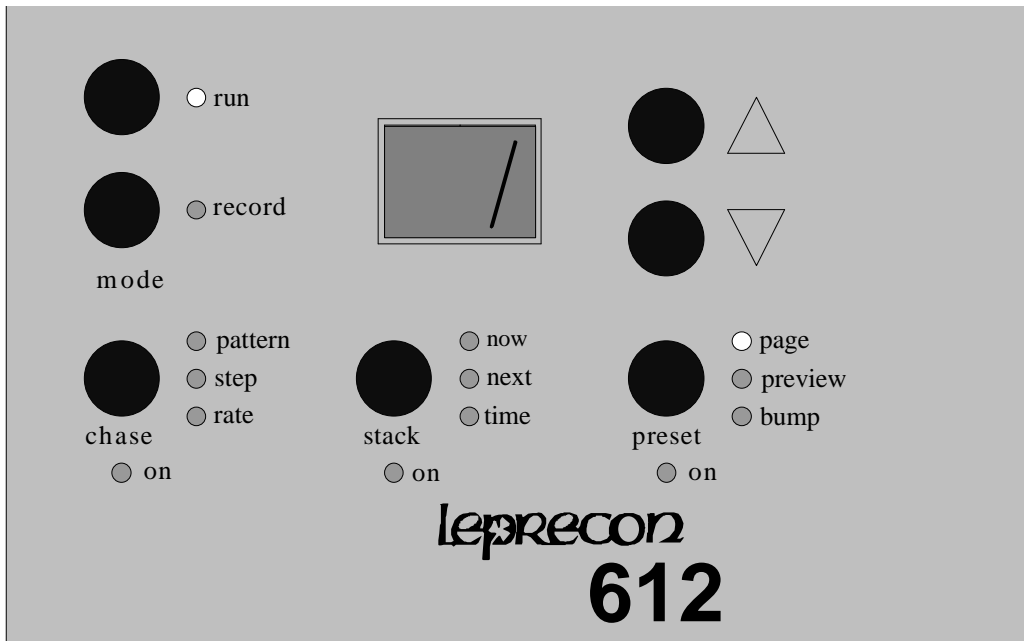

Page Number

When the 'page' Led is lighted, the display up and down keys cycle through the pages:

- "--" Manual mode, preset on Led off
- " 1" Page 1, preset on Led on
- " 2" Page 2, preset on Led on
- " 3" Page 3, preset on Led on
- " 4" Page 4, preset on Led on

In the Manual mode (page "--") the LP612 operates as a two scene console. If the page number is set to 1 or higher, the Y scene faders act as memory presets. Each page represents an entire set of presets; the LP612 can store 48 preset memories organized as four pages of 12 memories.

Preset Menu: LP624 ONLY

The Preset functions are controlled by pressing the 'preset' menu key on the front panel. When in the Preset mode, this button switches between four items:

page	Page Number
preview	Preview and Edit
bump	Bump Button control
patch	Dimmer assignment

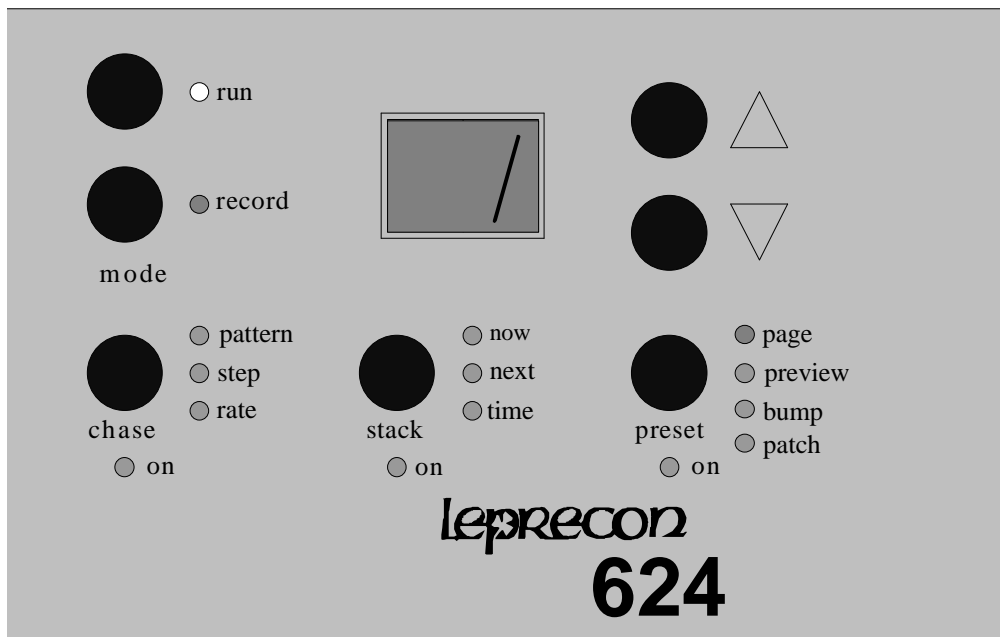

When the 'page' Led is lighted, the display up and down keys cycle through the pages:

- "--" Manual mode, preset on Led off
- " 1" Page 1, preset on Led on
- " 2" Page 2, preset on Led on
- " 3" Page 3, preset on Led on
- " 4" Page 4, preset on Led on

In the Manual mode (page "--") the LP624 operates as a two scene console. If the page number is set to 1 or higher, the Y scene faders act as memory presets. Each page represents an entire set of presets; the LP624 can store 96 preset memories organized as four pages of 24 memories.

Page Freeze

When the page number is changed, the presets are assigned a new set of memories. To prevent sudden changes on stage, any fader which is up (above 1 on the scale) maintains its current 'look' or memory scene. The fader will hold its scene until it is brought down to zero. At that time, it is then assigned a scene on the new page.

This page freeze method is also used when switching between manual mode and the memory presets mode. If a Y scene fader is up when the page number is switched from manual ("--") to page 1, the fader remains a channel in the Y scene until it is brought down. Once the fader is down, the fader is then assigned a memory preset scene in page 1. If a fader is assigned a memory preset scene and the fader is up, it keeps the preset scene up even when the page number is changed to manual mode ("--"). Only when the fader is brought down to zero does it revert to a channel in the Y scene.

Recording Presets Into Memory

Recording presets on the LP600 is quick and simple. Presets are always recorded from the console's current output. In other words, the levels of all lights, whether they are controlled from the X scene, another preset, the Cue Stack or any combination of these, can be recorded as the new preset. In general, what you see on stage is what you will get as a memory. Thus, when the master fader is at maximum, raising a particular preset fader to maximum will reproduce the exact output of the console at the moment that preset was recorded.

To record scenes into memory presets:

- 1) Press the presets menu key to light the 'page' Led.**
- 2) Use the display up and down keys to select a page number of 1 through 4.**
- 3) Place the console in Record mode by pressing the record button.**
- 4) Set the stage look using the X scene channel faders.**
- 5) Press the bump button beneath the desired preset fader.**
- 6) When finished recording, press the 'run' key.**

When the record key is pressed, the Led's located next to the bump buttons will begin to flash along with the record Led. This is to indicate that the buttons are ready to select a preset to be recorded.

When a bump is pressed, the scene is recorded. The preview Led is lit momentarily (along with the page Led), and the display verifies the number of the preset which was just recorded.

Illegal or impossible record commands will result in an error indication on the display:

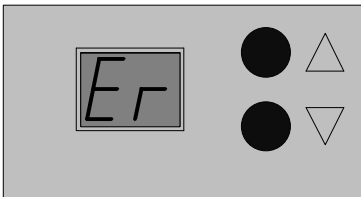

If the record button is pressed when presets are disabled (page --), the error message will be momentarily displayed. If the selected preset was in "Page-Freeze" mode, then the display shows a flashing error for a couple of seconds, and the preset is not recorded. The display then reverts to the page number.

While in the Record mode, scenes may be entered in any order into the LP600. Once recording is finished, press the "Run" mode button to return to run mode.

Preset Playback

Once scenes have been recorded into the Preset Memory faders on the LP600, they are immediately available for use. It is not necessary to leave the record mode to check or playback the memory.

With the master fully up, bringing up the fader for a memory scene will output the scene to the stage. Any number of faders can be up at one time, the scenes 'pile on' in a higher takes precedence fashion.

Previewing Presets

From the preset page display, pressing the Presets menu button again will set the console to the Preview mode. This will be indicated by the 'preview' Led. The preview mode is available only if the 'preset on' Led is lighted, which indicates a page number of 1 through 4 is selected.

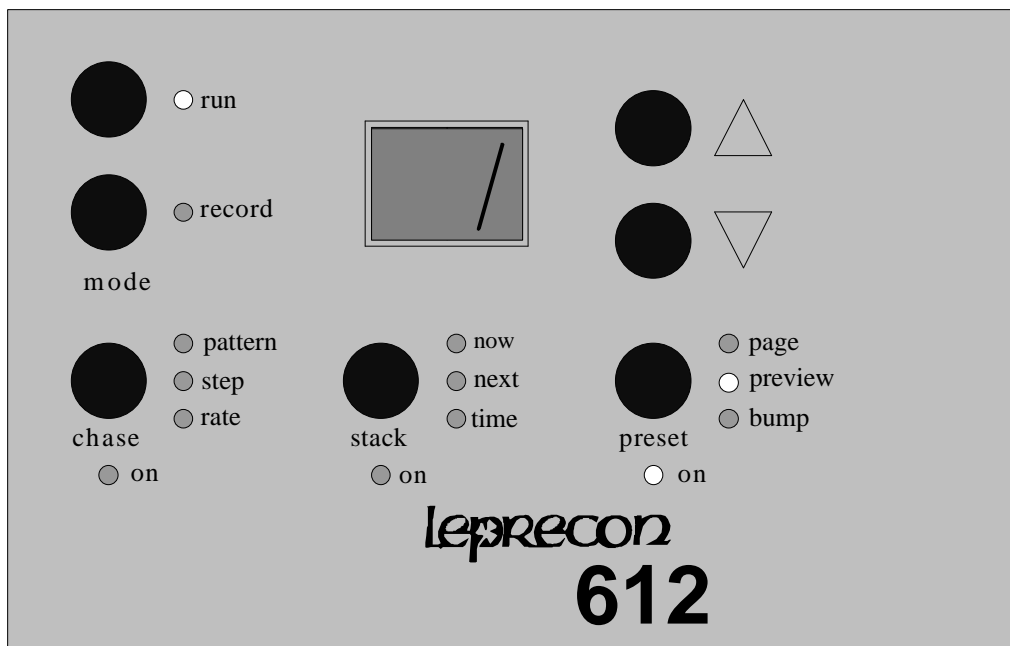

In Preview mode, the green output level Led's no longer represent the on-stage levels. The Led's now show the channel levels as stored in the selected preset scene. The Led's next to the bump buttons are steadily lit, indicating the bumps function as presets selects.

The first time this mode is entered after startup, the preset number 1 is selected. This number can be changed by pressing the up or down arrow keys or by pressing the bump button below the preset to be previewed.

Editing Presets

Single channel level changes can be quickly made to a selected preset. The X scene faders are used to adjust levels within the preset.

To Edit presets:

- 1) Press the 'preset' menu key to light the 'page' Led.**
- 2) Use the display up and down keys to select a page number of 1 through 4.**
- 3) Press the 'preset' key again to change to preview mode.**
- 4) Press the bump button of the scene to be edited.**
- 5) Press the 'record' key to start the edit.**
- 6) Use the X scene faders to 'grab' and adjust channel levels.**
- 7) Conclude the edit with the 'run' key, or by selecting another preset.**

During an edit, the Select Led's next to the bump buttons, as well as the 'record' Led will be lighted. This indicates that the buttons are available to select presets to be edited.

To edit a channel, first move the channel fader to the approximate level indicated on the Led. This will 'grab' the channel and the Led will begin to follow the fader position. Any number of channels in the preset may be adjusted in this fashion.

When all channels have been adjusted, press the 'run' key to save the modified preset. To edit several scenes in a row, press another bump button for the next preset to be edited instead of pressing 'run'. This will save the results of the first edit, and start the edit of the next preset.

Cue Stack

The Cue Stack feature of the LP600 offers many of the features that are useful in a small theatre board. Up to 50 cues can be programmed and played back in sequence with perfectly timed fades. Recording, editing and running the Cue Stack is quick and easy.

To use the Crossfade Stack, first press the 'stack' menu button below the display.

When in the Stack mode, this button switches among the 3 parameters or items:

- Now - The Now (current) scene
- Next - The Next scene
- Time - The Fade time from Now to Next

When the 'stack' key is pressed for the first time, the 'now' Led will light. The display will show:

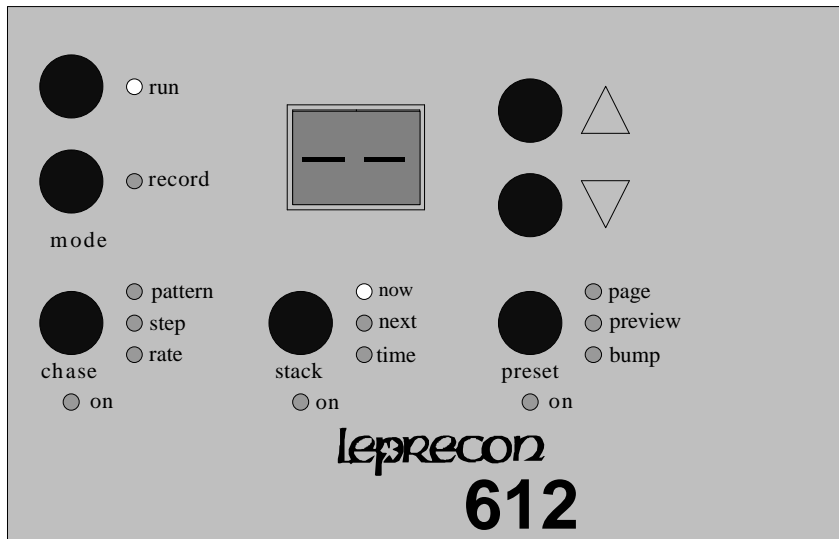

This indicates that the current stack cue is blank, and no output is present from the stack. The scene number which is below 1, "--", is the blackout scene. This blank scene can be set for the Next scene, and a fade to black will result.

In the case where both the Now scene and the Next scene are set to off, "--", the stack output is off and the 'stack on' Led is off. The stack crossfader and the GO button are now ignored.

Pressing the stack menu button a second time will light the 'next' Led, and the display will indicate the cue ready to fade. Pressing the 'up' and 'down' keys allow any of the 50 scenes to be set in the 'next' display:

The Crossfade from Now to Next can be started by pressing the "Go" button, or controlled manually by moving the stack fader from one end of it's travel to the other.

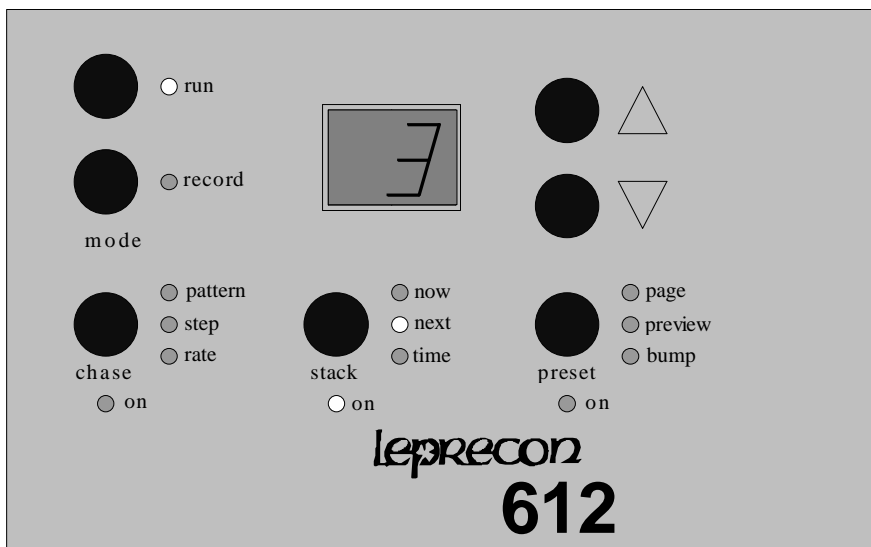

Recording Stack Scenes

Recording into the Stack places a stage look in the cue selected as 'next'. In the example, this would be Cue #1. To select another cue, use the display up and down keys.

Set up the stage look by using the X channel faders or any available presets. Press the 'record' button. The red Led next to the switch, will begin to blink.

Cues can be entered in sequence simply by setting scenes and pressing the 'record' button to record each cue. At any time, any cue number from 1 to 50 can be set and recorded. The sequence will advance from that point. For example, 'next' could be set to 10 This would be done by pressing the display up key until the number "10" appears on the display. The next time 'record' is pressed, Cue #10 will be recorded. The Cue number will automatically advance, and the next cue would be 11.

When recording is finished, return to Run mode by pressing the "Run" button. The Record and Select Led's will stop flashing and the bump buttons will return to normal operation.

To record Stack Presets:

- 1) Press the 'stack' menu button to display 'now' scene.
Use the 'down' key to set now to '--'
- 2) Press the 'stack' menu key again to light the 'next'Led.
- 3) Use the display up and down keys to select a cue number of 1 through 50.
- 4) Set levels on stage using manual channels or Presets.
- 5) Press the 'record' key once. The 'record'Led will begin to blink.
- 6) Press 'record' again to memorize the cue. The 'next' cue number will advance.
- 7) Continue setting and recording cues.
- 8) Press 'run' to end recording.

Assigning Fade Times

All cues in the Stack can be assigned a fade time. The time setting reflects the total time to finish a complete crossfade from Now to Next. The fade time is associated with the 'next' cue. Timed fades are started by pressing the 'go' button.

To enter fade times, press the 'stack' menu button below the display until the 'next' Led is lighted. Use the 'up' and 'down' keys to select the correct scene number. Press the 'stack' key again to light the 'time' Led. Use the 'up' and 'down' keys to set the fade time. Note that times are displayed in tenths of seconds from 0.0 to 9.9 seconds. The display then shows increments of 1 second from 10 to 59 seconds.

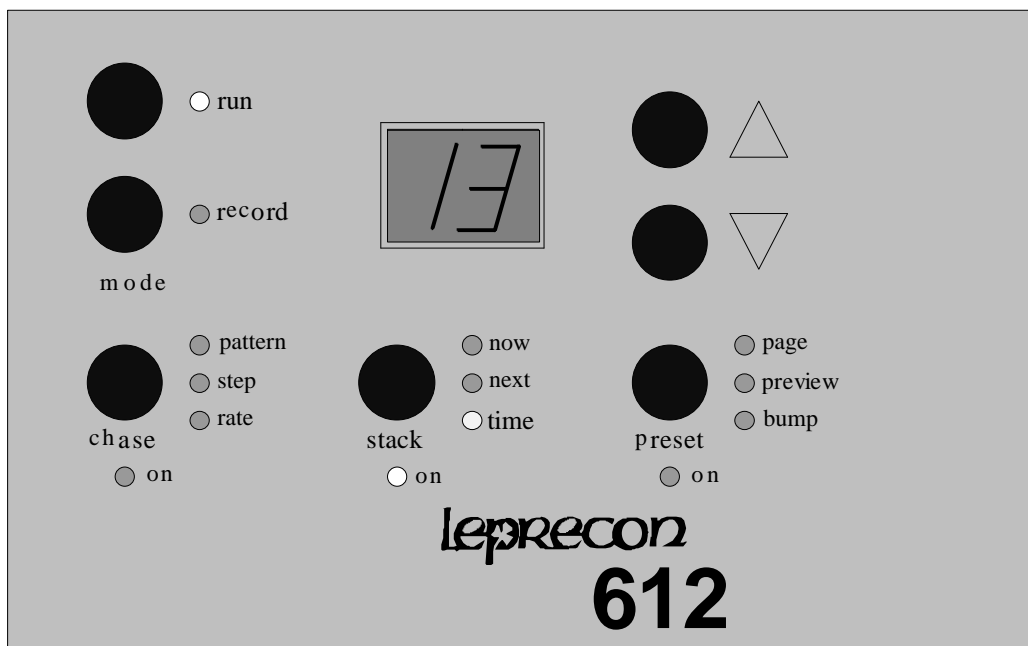

Default fade time

To simplify entering fade times, a default time may be entered for all cues. This can only be done when the Stack is cleared and all cues are erased. To select a default time for all stack cues, press the 'stack' key until the 'next' Led is lighted. Use the 'down' arrow to set the display to the blank scene:

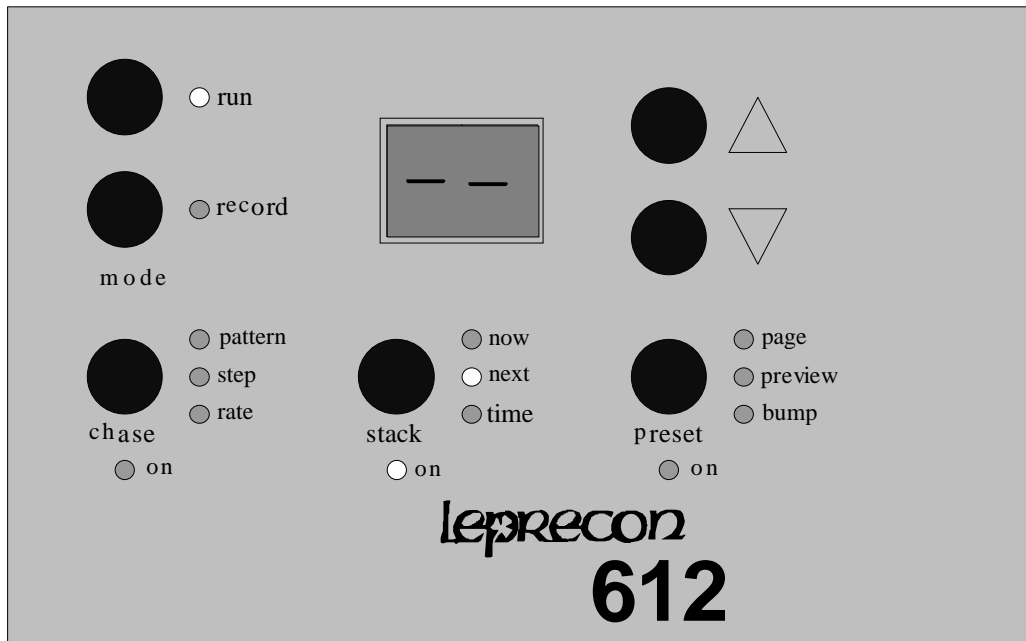

When 'next' has been set to the blank scene, press the 'stack' menu button again to light the 'time' Led. Enter the time desired as the default time for all scenes.

Now proceed to erase all stack scenes as described on page 11. The time that was entered for the blank scene will be inserted as the fade time for all stack scenes.

Stack Playback

The cues recorded in the Cue Stack can be used in several ways. The first is as a simple manual crossfade stack. As the crossfader is moved from one end to the other, a dipless crossfade is performed between the cues listed as Now and Next. This gives the board operator control of the transition.

An automatic timed fade is started by pressing the "Go" button. At the instant the button is pressed, the fade begins. The "Next" cue display can be re-set at any time to take cues out of sequence. The playback order will continue on sequentially from that point.

The green Led above the crossfader indicated the progress of the fade. The Led pops to full to indicate the beginning of the fade, and dims out as the fade continues.

When the scene number is changed from 1 with the DOWN button, the scene number displayed goes to "--", and the stack output is then turned off. This is how the stack can be quickly removed from the on-stage look.

Editing Cues

Once a Stack cue has been recorded, the level of a single channel in memory can be altered without re-recording the entire cue. In the Edit mode, the faders of the top scene are used to adjust the channel levels. The scene shown in the 'now' position on the display is the scene that will be edited. This allows scenes to be modified as they are seen on stage.

To Edit Stack Cues:

- 1) Crossfade to the cue to be edited.**
- 2) Press the 'stack' menu key to light the 'now' Led.**
- 3) Press the 'record' key to start the edit.**
- 4) Use the X scene faders to 'grab' and adjust channel levels.**
- 5) Conclude the edit by pressing the 'run' key.**

To enable editing the scenes in the Stack, the console must be placed into the Record mode and the Stack menu button must be pressed to select the Now scene mode. The scene number set in Now is the number of the scene being edited.

In edit mode, the output level Led's are used to show the contents of the selected memory. The X scene faders directly below the Led's are used to adjust channel levels. The faders take control of a channel when the fader position matches the level recorded into memory. The brightness of the level Led and the value in the display will begin to change when the fader takes control of the channel. For example, to edit a channel that was recorded at 100%, it would be necessary to bring the top scene fader for that channel up to full to capture the channel, moving the fader down from that point would reduce the level of the channel.

Any number of channels can be adjusted in one edit, using the X scene faders.

To edit a sequence of stack scenes as they are being played back, simply leave the console in the Now mode. When a scene is encountered that needs editing, press the 'record' button. This places the scene in the Edit mode and changes can then be made. The console may be left in Edit mode while a series of scenes are played and edited. This is handy for rehearsal-type changes.

Chase

The Chase functions are activated by pressing the 'Chase' menu key on the front panel. The board will enter the Chase mode.

When in the Chase Menu mode, this button switches among the 3 parameters or items:

- Pattern - The Chase pattern to be viewed
- Step - The current step number
- Rate - The current Chase rate

The Chaser level is controlled by the "Chase Level" fader. When the fader is down, the Chaser is off. When the fader is brought up, the Chaser is started on the first step of the selected pattern.

Pattern

The first item in the Chase menu is the Chase Pattern mode. This is indicated by the 'pattern' Led being lighted. The 2 digit display indicates the pattern number. This number can be changed using the UP and DOWN buttons. Patterns 1 through 4 are pre-programmed Chases that cannot be altered. Patterns 5 through 11 are custom patterns that must be recorded before use.

When the pattern number is changed to below 1, the display shows "--", and the Chaser is off and disarmed.

When the pattern number is set to 1 or higher, the Chaser is on. When the Chase fader is brought up, the Chaser starts running and the Chase appears on stage at the level of the fader. Each pattern has up to 24 steps associated with it.

Step

Pressing the 'Chase' menu key a second time will light the 'step' Led and the display will show the current step number of the selected Chase pattern. While the Chase is running, the number moves at the rate recorded for the Chase. When the Chase is stopped, the number displayed is the last step viewed before it was stopped.

Rate

The 'rate' mode displays the Chase rate in percent of full speed. The 'up' and 'down' buttons can be pressed to increase or decrease the speed of the Chase. There are 100 accessible rates using these buttons.

The Chase rate can also be set using the Chase 'tap' key. When a Chase is running, tapping the tap button synchronizes the Chase rate with the tap.

Chase rate is saved with the Chase. When the Chase is recalled, the rate will automatically be set.

Pre-programmed Chases

The standard Chases can be run immediately without recording steps, but cannot be altered. These Chases are selected by setting the Chase pattern display to positions 1 through 4. The four standard Chases have the following effects:

1) Straight

A single channel on, advancing sequentially from 1-2, 2-3, and so on until step 6 loops back to channel 1.

2) Reverse

Same as Chase 1 except begins with channel 6, and proceeds to light lower channel numbers until 1 is reached. The next step loops back to channel 6.

3) Zig-Zag

A ten step Chase that starts with only channel 1 up, and advances sequentially until channel 6 is lighted. Step 7 starts the Chase back down from channel 6 to 5, and it proceeds back down to channel 1, when the pattern repeats.

4) Straight 12 channel

Same as Chase 1 except advancing sequentially from 1 to 12, when the loop repeats.

Recording New Chases

The Chaser section of the LP600 allows for seven custom Chases to be programmed by the user. Each of these patterns can consist of up to twenty-four steps, each consisting of any combination of channels. These programmable Chases are available on patterns 5 through 11.

To record a custom Chase:

- 1) Set the pattern display to one of the patterns 5 to 11.
- 2) Move the 'Chase' fader to zero. The Chase cannot be running while steps are recorded.
- 3) Press the 'Chase' menu button a second time to enter 'step' mode.
- 4) Press the 'record' button.
- 5) Set the channels of the Chase step using the bump buttons or X scene faders.
- 6) Press the 'up' key to advance to the next step.
- 7) When finished, press the 'run' key to end programming.

Level Chases: LP624 Only

The LP624 has provision for programming channel levels as Chase steps. This allows any value between 0 and 100% to be programmed as a channel level instead of the on/off programming that is used on the LP612.

The programming of levels is identical to the procedure outlined above for Chase recording. If the bump buttons are used to set channel levels, the only values used will be off and on. If the X scene faders are used, the level set with the fader is memorized into the Chase step.

Pattern Edit

When a custom Chase is entered in the LP600, a fixed length for that Chase is established. Pattern edit allows the Chase steps to be altered without changing the length of the Chase. Pattern edit only can be used for a Chase that has been already programmed as described above.

During a pattern edit, the 'tap' button steps the Chaser to the next step without changing the Chase length. The 'tap' button can be used to step through all the steps of the Chase pattern to verify it is correct.

First, select the pattern to be changed. Press the 'Chase' menu key to light the 'pattern' Led. Use the 'up' and 'down' keys to select the pattern. Press the 'Chase' menu key again to light the 'step' Led. The display will show the current step of the selected pattern.

Press the 'record' key to start the edit. In this mode, the Chaser is stopped regardless of the recorded rate. The output Led's will show the programmed channels of the indicated step. Use the 'tap' key to advance the Chase step by step. When a step is to be edited, use the bump buttons or X scene faders to turn channels on or off..

Step edit

When the Chase pattern is 5 or higher and the Record mode is on, step editing allows changing the number of steps in the selected pattern.

First select the pattern to be changed. Press the 'Chase' menu button to light the 'pattern' Led then press the 'record' button. The pattern number must be set to 5 or higher.

Press the 'Chase' menu key a second time to show the current step number. The step number can be changed using the 'up' and 'down' keys. As steps are added using the 'up' key, the channels programmed into each step may be set using the bump buttons and faders.

The step number showing when the 'run' button is pressed becomes the new length of the Chase.

Repair and Warranty Information

CAE will repair any defects in materials or workmanship on the LP600 for a period of one year from the date of sale. The equipment must be returned postpaid to the factory, and CAE will pay return shipping charges. CAE is not responsible for incidental damages, or for damage as a result of misuse or abuse. It is the responsibility of the owner to determine the suitability of the console for any specific application.

Any return to the factory must be authorized by our service department. Do not return any equipment without first calling for an authorization number. The CAE service department may be reached at 810 231 9373 during business hours, or a message may be left after hours. Our fax number is 810 231 1631.

CAE, Inc.
PO Box 430
10087 Industrial Drive
Hamburg, MI 48139